

1

Beleuchtung
Lighting

Elektro-Installation nur vom Fachmann ausführen lassen!
Electrical installation should be carried out by an electrician only!

Ständermontage / Mounting on stands

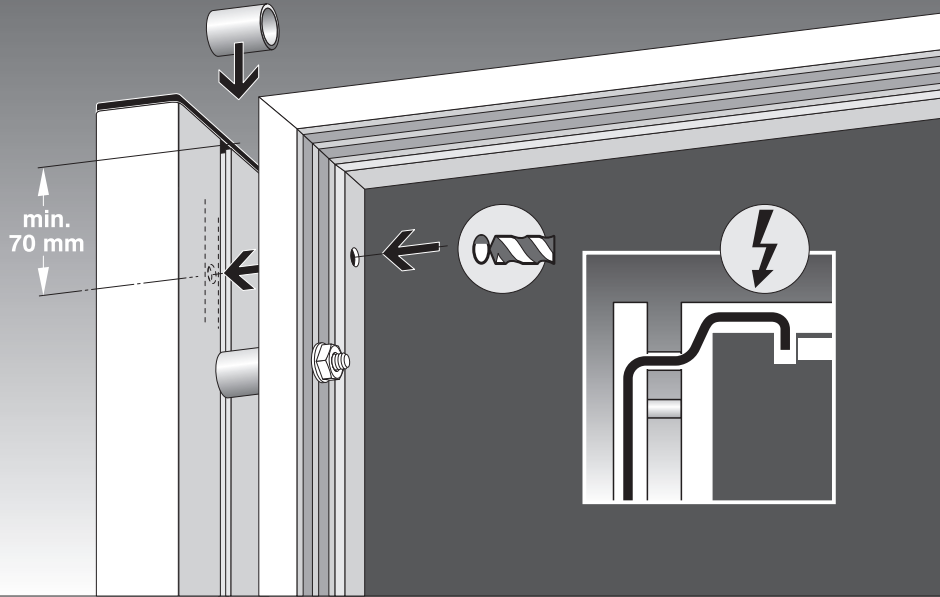

Wandmontage / Mounting on walls

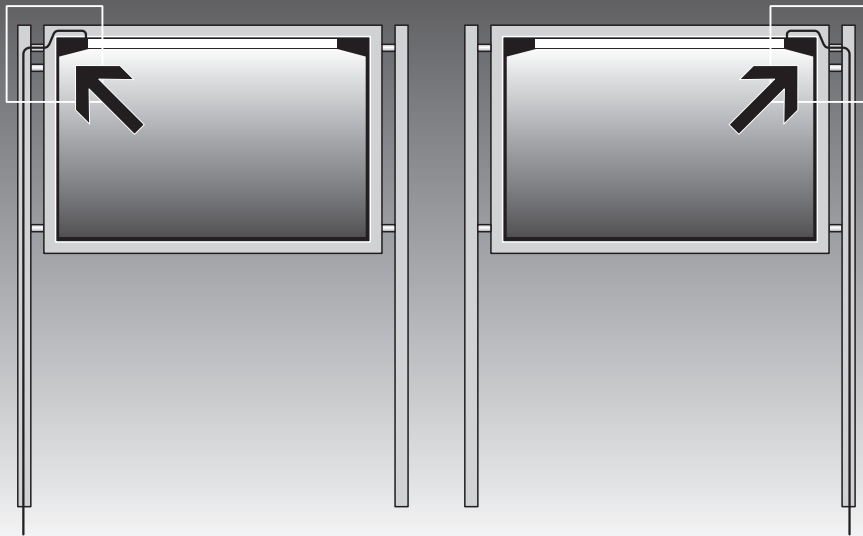
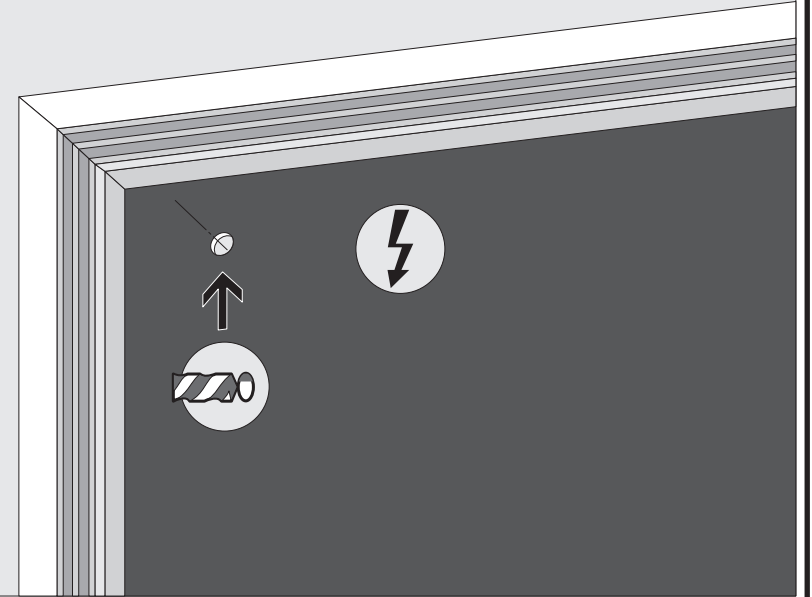



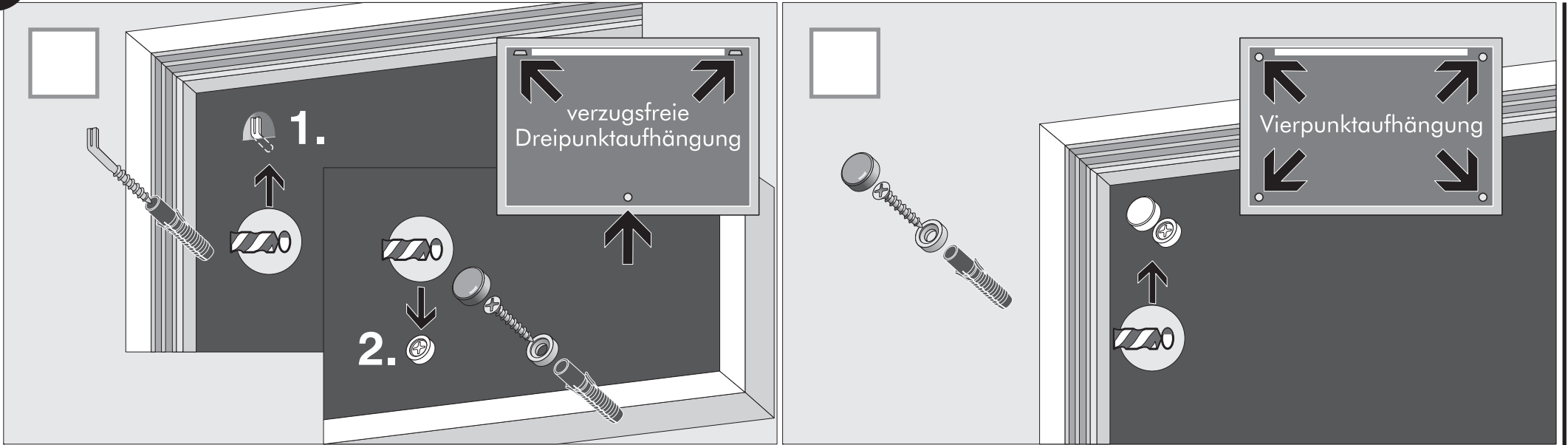



2 Wandmontage / Mounting on walls



Ständermontage
Mounting on stands

Ständer und Schaukasten nur liegend montieren!
Showcase has to lay on a flat surface while mounted to the stands!

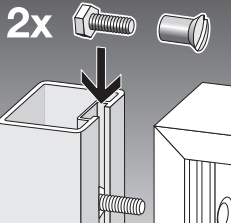
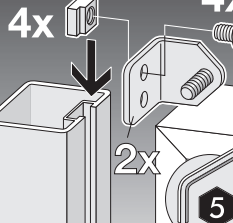
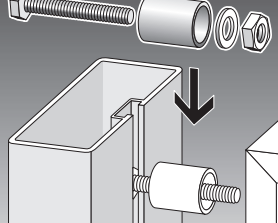
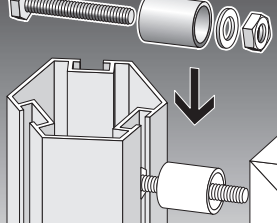
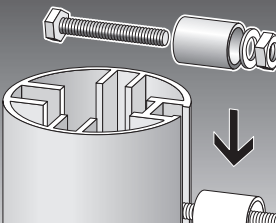
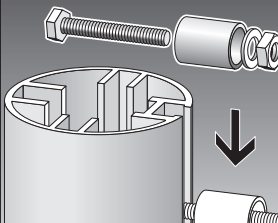
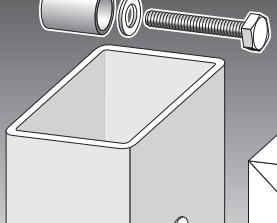
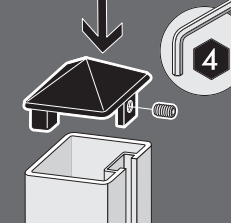
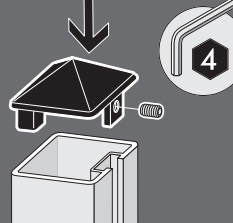
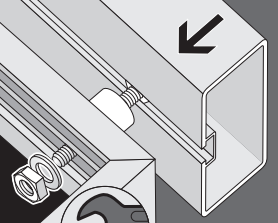
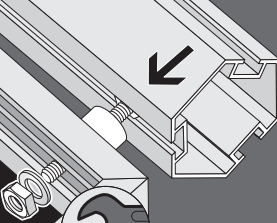
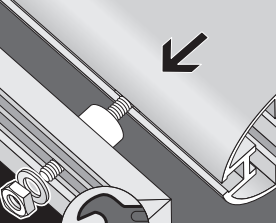
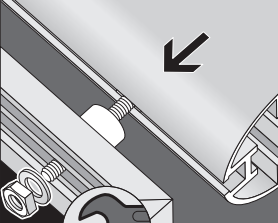
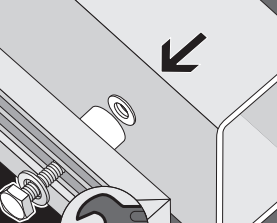
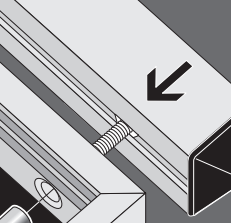
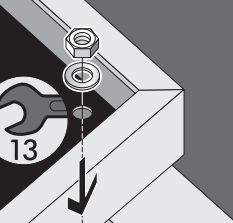
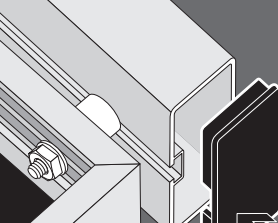
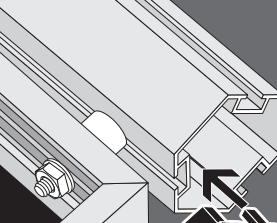
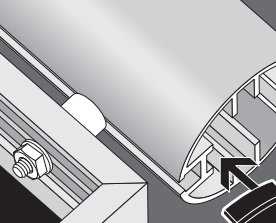
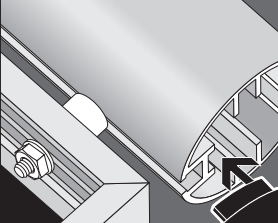
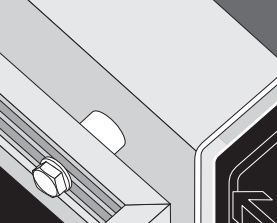
<p>Vierkantröh / Square tube 40 x 40 mm</p> 	<p>Vierkantröh / Square tube 40 x 40 mm</p> 	<p>Rechteckrohr / Rectangular tube 80 x 40 mm</p> 	<p>Sechseckrohr / Hexagonal tube SW 60 mm</p> 	<p>Rundrohr / Circular tube Ø 80 mm</p> 	<p>Rundrohr / Circular tube Ø 80 mm</p> 	<p>Rechteckrohr / Rectangular tube 100 x 60 mm</p> 
<p>2x</p> 	<p>4x</p> <p>4x</p> <p>2x</p> <p>5</p> 					
<p>4</p> 	<p>4</p> 	<p>13</p> 	<p>13</p> 	<p>13</p> 	<p>13</p> 	<p>13</p> 
	<p>13</p> 					

Austausch der Scheibe

Umlaufende Glasdichtung herausziehen(1)
Schrauben an beiden Seiten des Flügels herausdrehen(2), Profilteil abziehen(3)
Vorsicht!
Die Glasscheibe oder ggf. Glasstücke können dabei herausfallen!

Exchange of the window pane

Remove the rubber seal (1)
Remove the screws on both sides of the door frame (2)
Remove the bottom section of the frame (3)
Caution! Glass could fall out! (3)
After replacing the glass replace the bottom of the frame, reinsert the screws.

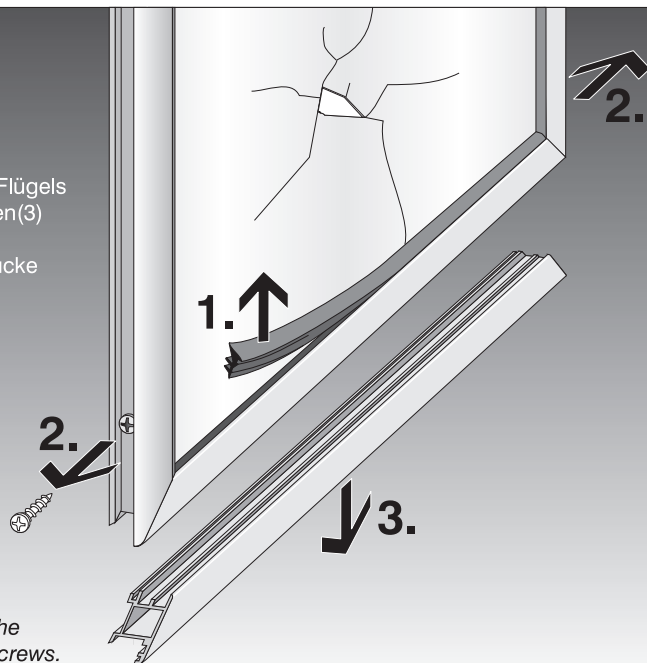

Austausch des Schlosses

Das Schloss mit einem Kunststoff- oder Gummihammer vorsichtig aus dem Profil herausschlagen(1)

Exchange of the lock

Carefully remove the lock using a plastic or rubber hammer.
When replacing the lock do not hammer directly on the cylinder.
Drill a hole (18-20 mm diameter) into a wooden block.
Place the block on top of the cylinder when replacing the lock.

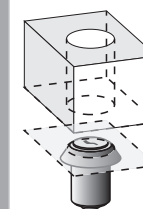

Beim Einschlagen des neuen Schlosses nicht auf den Zylinder schlagen, sondern nur auf das Gehäuse(2).
Verwenden Sie einen Holz- oder Kunststoffklotz, in den ein Loch mit 18-20 mm Durchmesser gebohrt wurde. /...

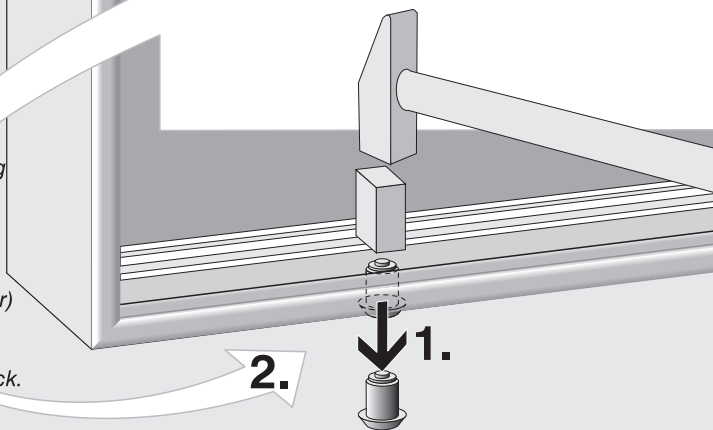

Drehtüren für Vitrinen

Revolving doors for showcases



Schiebetüren Sliding doors

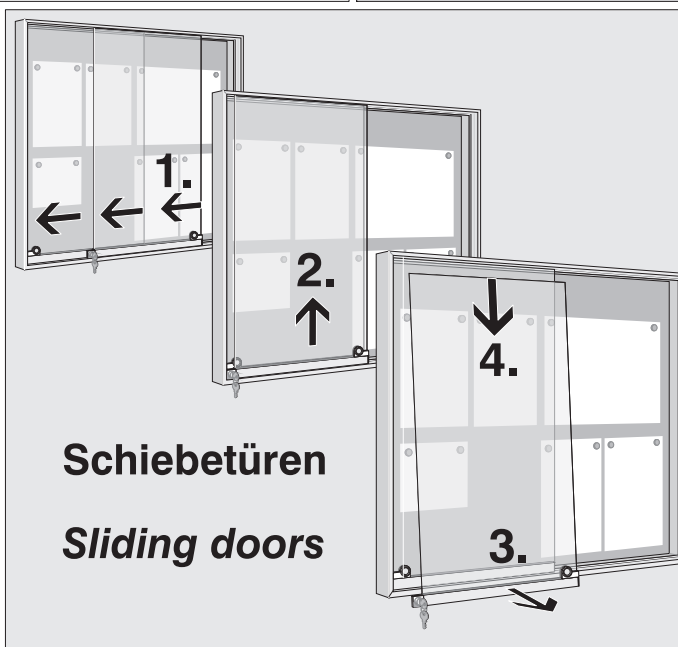

Drehtüren für Plakat-Schaukästen

Revolving doors for billboard display cases

